

Article number: 20192B32B32562BL

Description: E+G

T-angle clamps GN192-B32-B32-56-2-BL

Measures

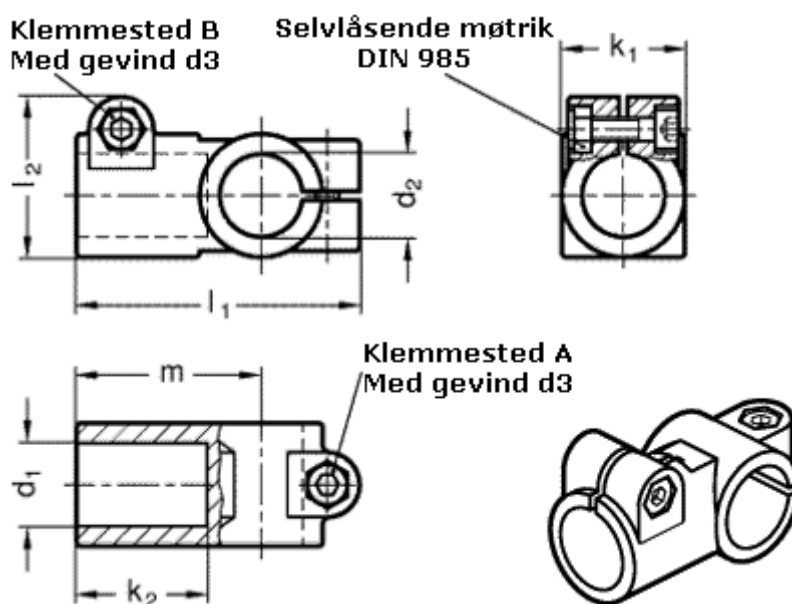

d1 = B32
d2 = B32
d3 = M10
k1 = 56
k2 = 62.0
l1 = 129
l2 = 69.0
m = 88